

Before start, Please carefully read the explanations!

F4



Specification:

Wingspan:2538mm/100”

Length:1753mm/69”

Flying Weight:~20KG

C.G:~357.9mm back from the landing edge at wing root

INSTRUCTION MANUAL



SAFETY PRECAUTIONS

This R/C airplane is not a toy!

(The people under 18 years order is forbidden from flying model)

First-time builders should seek advice from people having building experience.If misused or abused,it can cause serious bodily injury and damage to property

Fly only in open ares and prederably at a dedicated R/C flying site.

We suggest having a qualified instructor carefully inspect your airplane before its first flight. Please carefully read and follow all instructions included with this airplane. your radio control system and any other components purchased separately.

REQUIRED FOR OPERATION (Purchase separately!)



CAUTION: For details concerning the equipment listed below (size, maker, etc.), check with your hobby shop.

- 1 A minimum 6 channel radio for airplanes (with 8 servos), and dry batteries.



CAUTION: Only use a minimum 6 channel radio for airplanes! (No other radio may be used!)
6 channel radio for airplane is highly recommended for this model.

12 AA-size Batteries

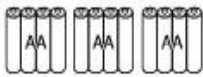

A minimum 6 channel transmitter for airplanes.



For handling the radio properly, refer to its

18-20KG Turbine

- 2 Engine and Muffler

Model Airplane Engine 18-20KG Turbine



3

Sponge Sheet



Gasoline tube



Fuel Filter



4

Glue



Instant Glue

Epoxy Glue

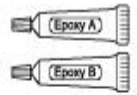

5

Optional electric retract set



TOOLS REQUIRED (Purchase separately!)

Sharp Hobby Knife



Phillips Screw Driver (l, m, s)



Awl



Needle Nose Pliers

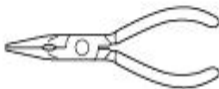

Wire Cutters



Scissors

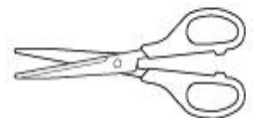

BEFORE YOU BEGIN

- 1 Read through the manual before you begin, so you will have an overall idea of what to do.
- 2 Check all parts. If you find any defective or missing parts, contact your local dealer.
- 3 Symbols used throughout this instruction manual, comprise:
- 4 We strongly recommend you use the thread lock for all the screws when you build your model.



Apply epoxy glue.



Drill holes with the specified diameter (2mm).



Cut off excess.



Pay close attention here!



Apply instant glue (CA glue, super glue).



Cut off shade portion.



Ensure smooth non-binding movement while assembling.



Assemble left and right sides the same way.



Must be purchased separately!

Do not overlook this Symbol!



Warning!

F4 Accessories

	TP Screw (2.3X8mm)	20
	TP Screw (2.3X12mm)	10
	Socket Head Screw (2.6X12mm)	4
	Hex Screw (4X25mm)	10
	Washer (4x8mm)	6
	Hex Screw (3x25mm)	4
	Hex Screw (2x12mm)	14
	Hex Screw (3x10mm)	10
	Blind Nut (2mm)	14
	Blind Nut (3mm)	10
	Washer (2X5mm)	14
	Washer (3x6mm)	10
	Push Rob (3X88mm)Flap	2
	Push Rob (3X68mm) Aileron	2
	Push Rob (3X78mm) Elevator	2
	Push Rob (2X130mm) Rudder	2
	Push Rob(2X35mm)Front gear cover	2
	L Push Rob (2x30mm)	2
	Fiber Hron (3mm hole)	8
	Plastics Hron	2
	Plastics keeper	2
	Clevis (3mm)	12
	Clevis (2mm)	10
	Pivot&Round hinge (5X68mm)	1

Servo Accessories

	L Bracket (25x20x3)	14
	Philip's head screw(3x10mm)	28
	Socket Head Screw (3x8mm)	28
	Blind Nut (3mm)	28
	3mm Washer	28

	Servo Cover	4
	Main gear cover A	1
	Main gear cover B	1
	0.5 Fiber Elevator part A	2
	0.5 Fiber Elevator part B	2
	Wing Alu tube (25X830mm)	1
	Wing Alu tube (20X453mm)	2
	Rudder Alu tube (12X215mm)	1
	Tank	2
	Rudder Steering Part(3mm)	1
	Connect Elevator Part	1

Retract Accessories

	Front Gear	1
	Main Retract	2
	Gear Cover Washer(2mm)	2
	Positioning gear cover fiber sheet(2mm)	2
	Socket Head Screw (3x10mm)	8
	Hex Screw (2x12mm)	4
	Blind Nut (2mm)	4
	Push Rob (2x48mm)	4
	Main Retract Screw(3x20mm)	12
	Washer (3x6mm)	8
	Controller	1

1. Fix the servo on the servo cover of the wing by Screw and glue . Fix the Fiber horn (3mm hole) in flap and aileron with glue

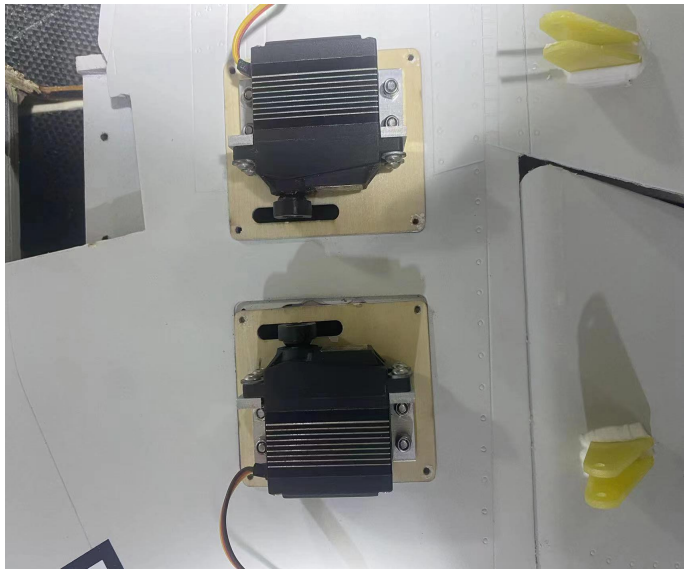

2. Connect the servo and fiber horn with push rob.



3.Lock the wing Alu tube by this hole (as the picture)



4. More picture about the lock hole of wing

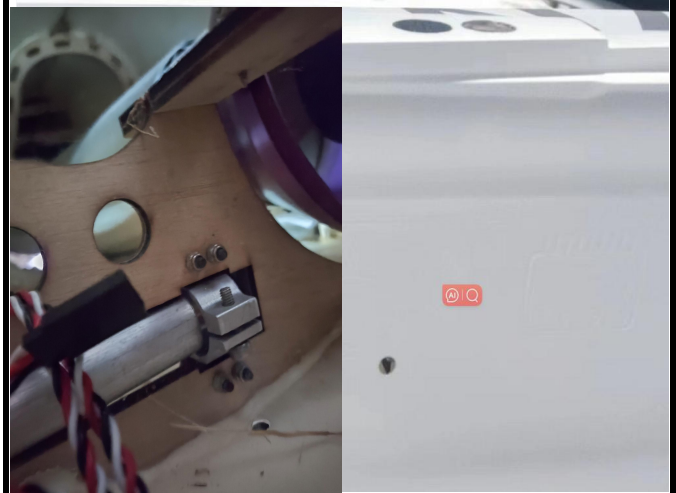

5. Epoxy the wood block to appropriate position on the servo tray, Install the servo to the servo tray as below.

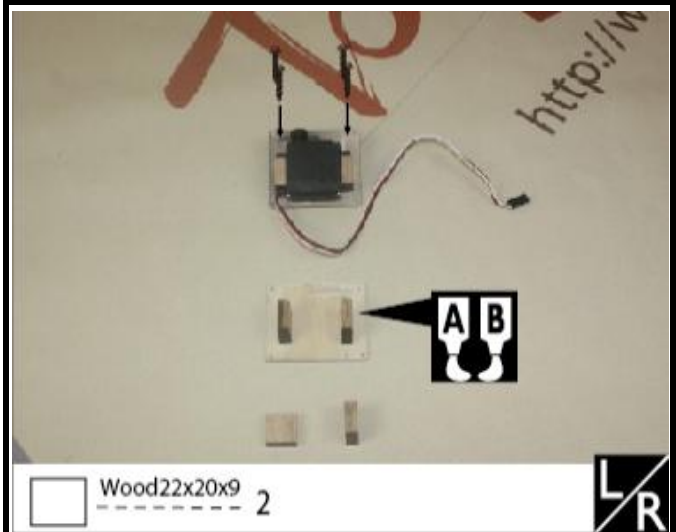

6. The sketch map of how the servo arms connect to the horns.

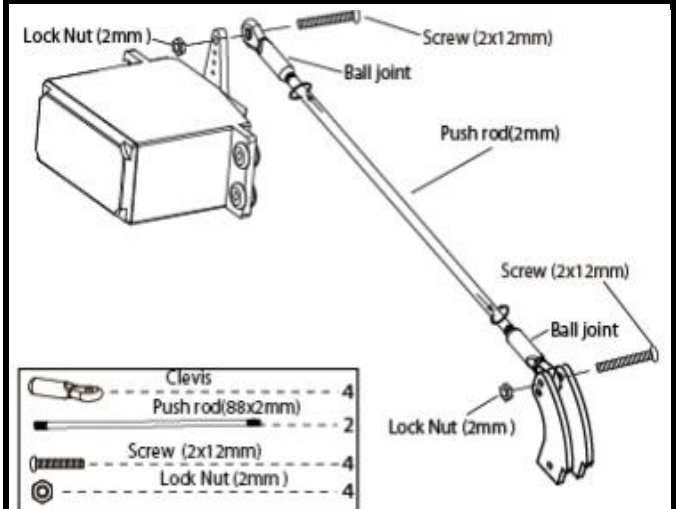

7. Install the servos in the frame of the front of fuselage utilising simple aluminum L brackets to hold them to the hatches .

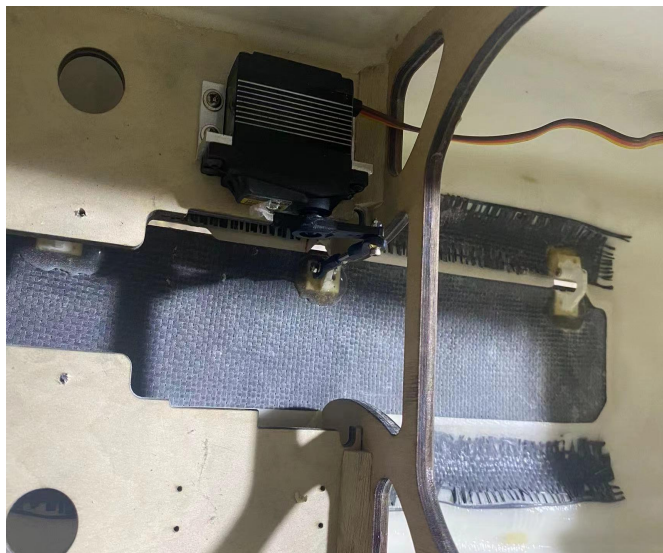

8. Connect servo and this part as picture with push rob



9. Fix the wooden part in front of fuselage with screw



10. The completed picture about the wooden part

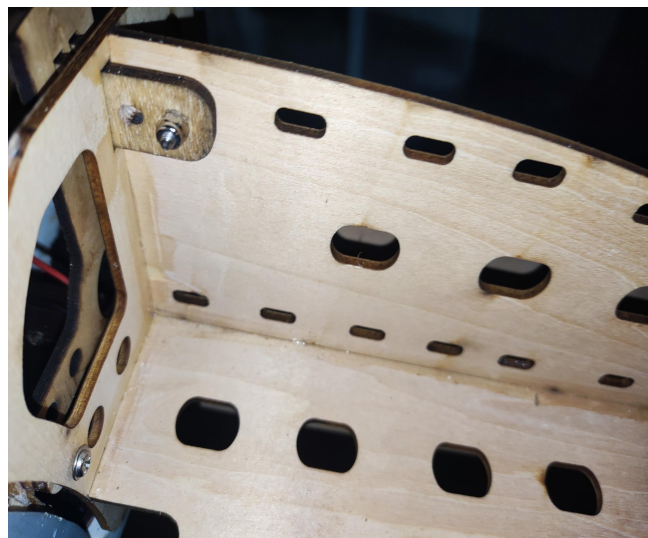

11 Lock the cowling on the front fuselage with Alu Part



12. Fix the front fuselage into fuselalge with screw. The threaded hole place as same as picture.

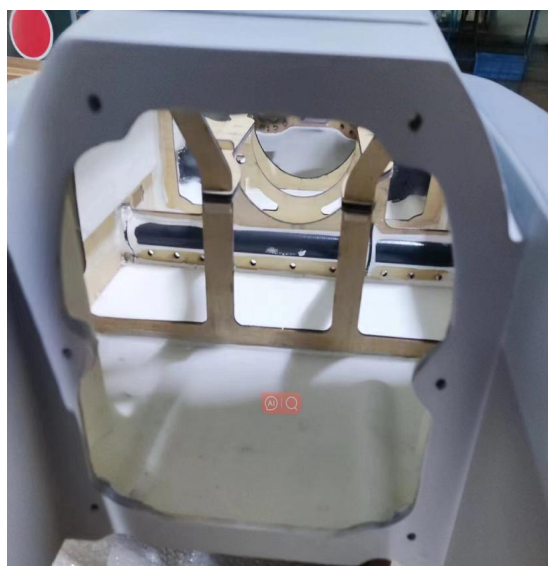

13. Put the steering part into the rudder.



14. After the rudder install into the rear fuselage .Parts (as shown) install into steering part and lock it with screw.

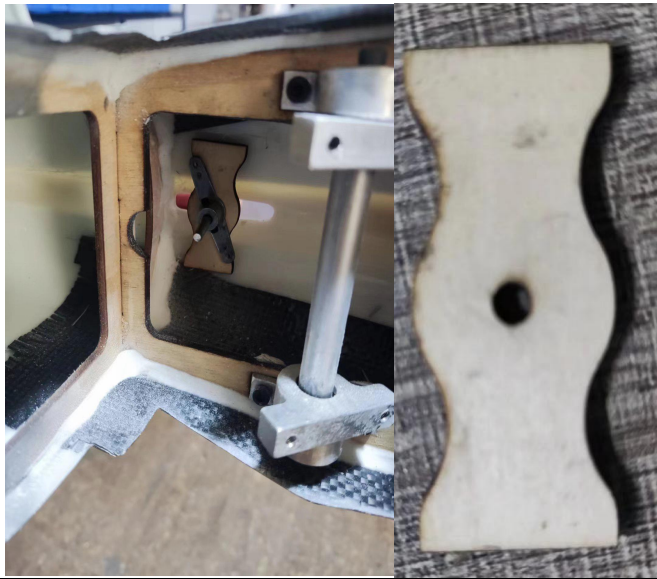

15. Parts (as shown) install into steering part and lock it with screw. And glue the white part as fixed.



16. Fix the servo .Connect the push rob to the steering rudder part.

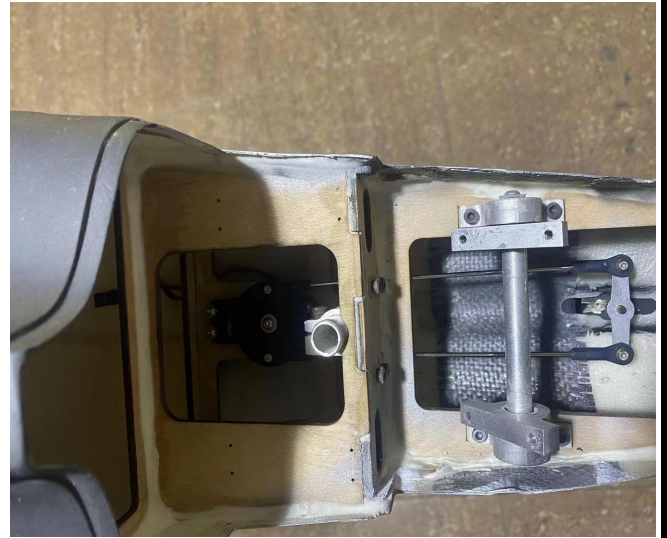

17. Fix the Elevator. And fix the elevator connect part (as the picture) on the elevator. Then fix the servo and connect the servo and elevator part with push rob.

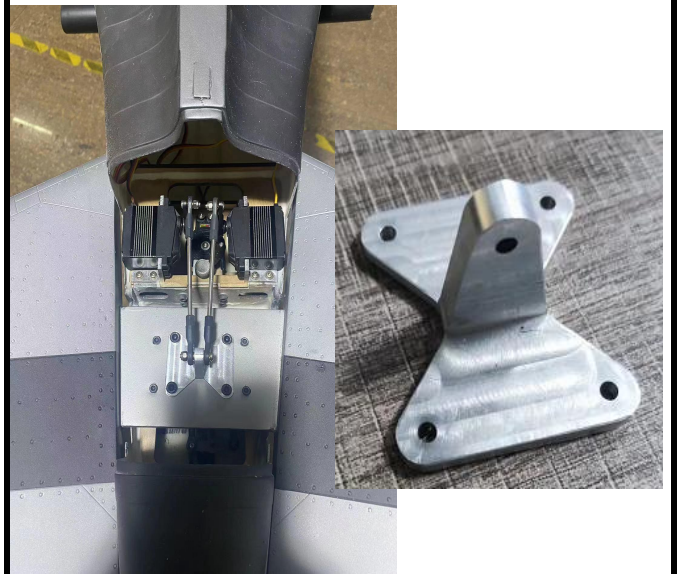

18. After install the Elevator. Need to adjust the mid line of elevator to parallel to the lines in the picture

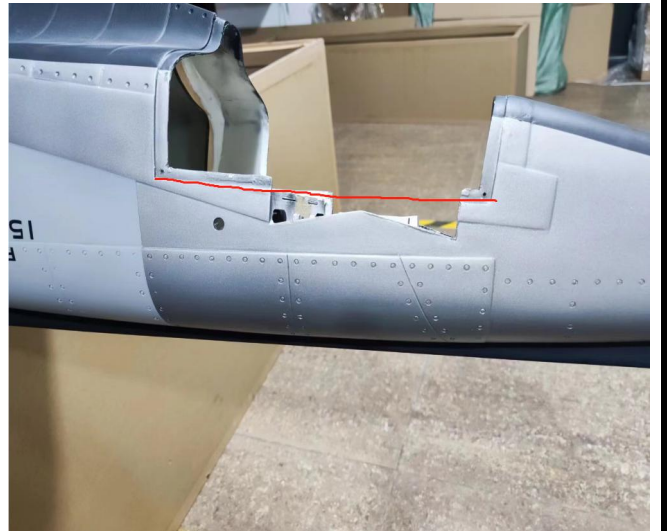

19. More picture about the elevator



20. Fix the elevator cover with screw.



21. Put the pivot & round hinge into the parts



22. Connect with tail of fuselage.



23. Fix the main gear cover A on fuselage with hinge



24. More picture about the cover installment

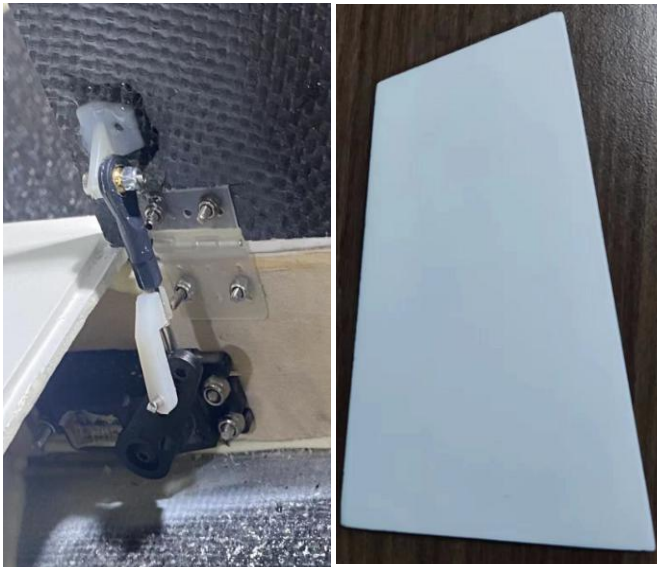

19. Connect the servo with the part (as the picture)



20. Fix the main gear B into the main gear with screw



21 . More picture about the main gear B



22 More picture about the servo of front gear

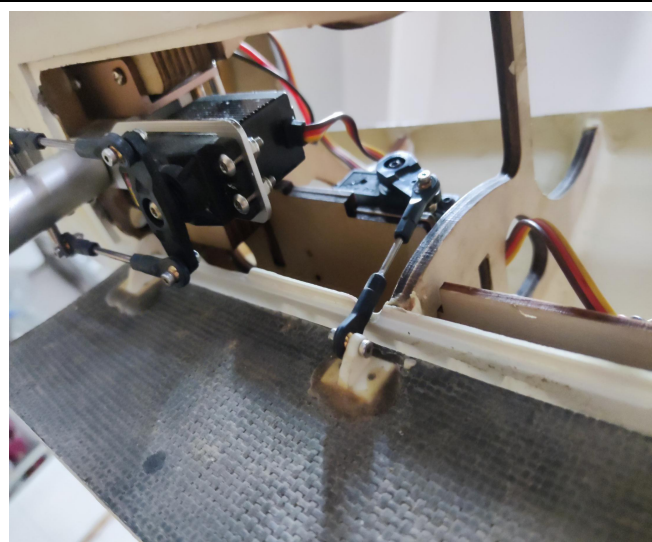

23. Fix the Missile rack on the wing with screw and AB glue.



24. Fix the Missile on the rack with screw



Completed the installment of the F4



27. Adjust the travel of each control surface to the values in the diagrams. These values fit general flight capabilities. Readjust according to your needs and flight level.

28. Adjust the travel of each control surface to the values in the diagrams. These values fit general flight capabilities. Readjust according to your needs and flight level.

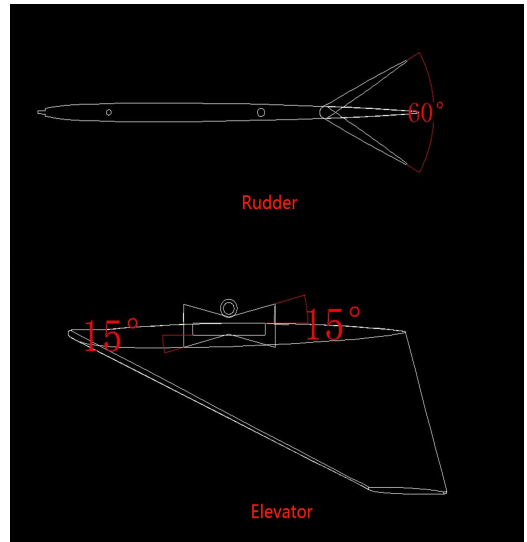
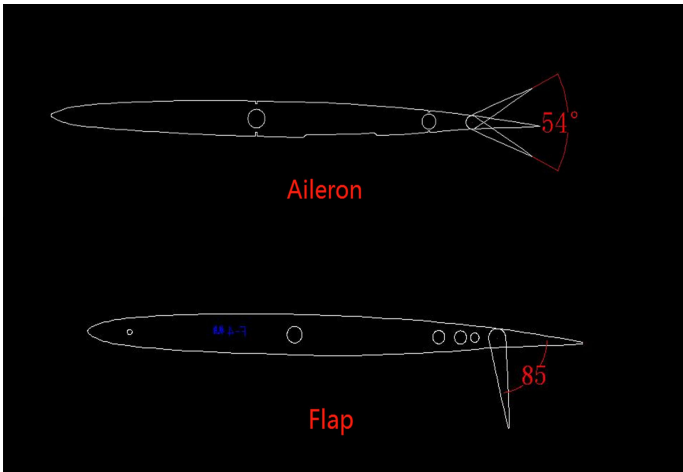

29. Check all the data well. make sure all sections glue tightly. Otherwise if coming off during flights, you'll lose control of your airplane which leads to accidents!

30. C.G.: Never fly before checking the CG's required position. Never fly the model without well balancing.

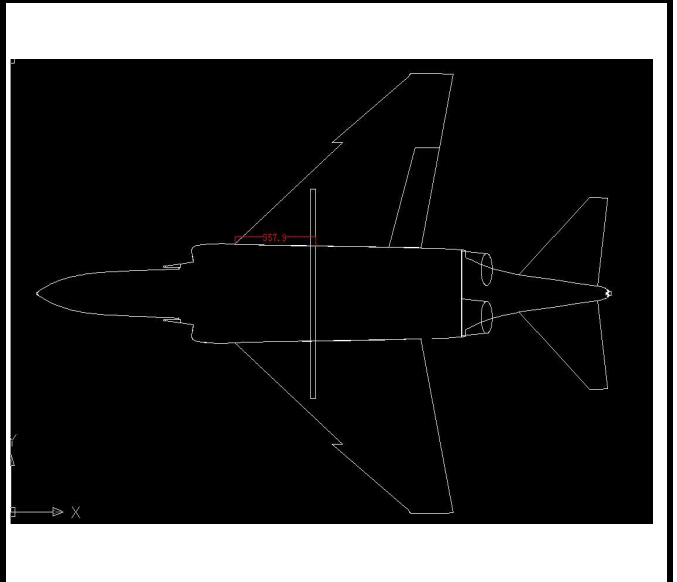
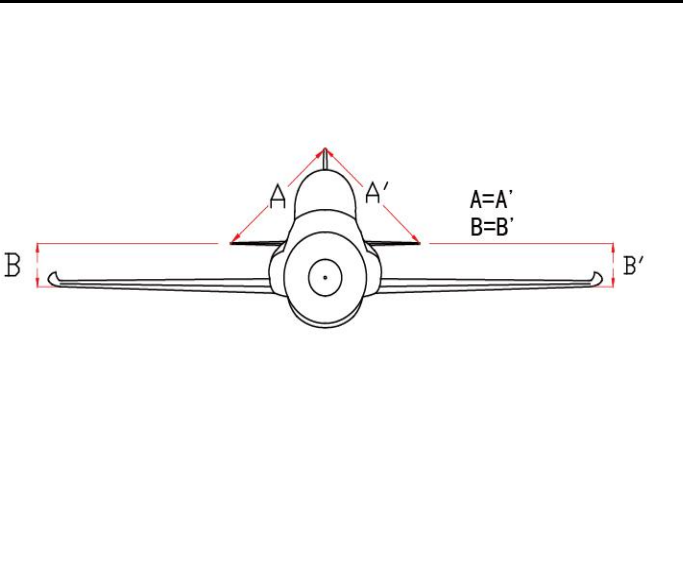



Instructions :

1. After power on, press the test button for the first time. All hatch LIDS must be open and all landing gear must be open. If any hatch not be opened, the positive and negative of the related servo should be set; If the landing gear does not open, you need to convert the motor plug on the control box. This step is very important, and only by this way can it match the timing set of the program.

2. When setting up the forward and backward direction of the servo, better to plug all retract mode button to the upposition (Mode 1).

3. When setting the blocking current, it is necessary to know that the corresponding indicator light will be off during the operation of the retractable motor. When the retractable and retractable stand is in place, the motor will stop and the corresponding indicator light will turn on at this time. If the motor stops running, the indicator light is still off, indicating that the set blocking current is too large. At this time should reduce the blocking current, to ensure that the motor after blocking, the corresponding indicator light is on. Otherwise, the electricity will be easily damaged .

Therefore, during the process of use, should pay attention to the state of the corresponding indicator light.

I. Working voltage: 6-8.4V (12V power supply for large landing gear, please contact the owner)

II. The blocking current is adjustable. It is suitable for all electric retraction racks under 35KG on the market.

III. The power supply voltage of the steering gear on the hatch cover can be set

IV. The forward and backward direction and stroke of the door servo can be set separately

V. Each gear door servo can be set with 2 modes of retracting separately (1. After the landing gear opened, the gear door will not be retracted; 2. Landing gear open, gear door retracted)

VI. Specification: three in one controller(74*64*15MM)